

Optimization of an Adapta™ Kinase Assay for MKNK2

Overview

This protocol describes how to perform an Adapta™ assay with the kinase MKNK2. To maximize the ability of the assay to detect ATP-competitive inhibitors, we developed the assay using 10 μ M ATP. However, the assay could be re-optimized for other ATP concentrations in an analogous manner. A typical procedure is as follows:

1. Optimization of the concentration of Alexa Fluor® 647 ADP tracer to be used in the assay

A tracer titration is performed to determine the optimal concentration of tracer to elicit an approximately 50% change between the minimum and maximum TR-FRET emission ratios (the EC₅₀ value) at the desired ATP concentration.

For this particular protocol, the optimal concentration of tracer has already been determined and the tracer optimization step is skipped to save time and reagents. However, if either the assay buffer or ATP concentration are modified, optimization of the Alexa Fluor® 647 ADP Tracer concentration should be repeated. Detailed instructions on how to perform a tracer optimization is available in Appendix A.

2. Optimization of the concentration of kinase to be used in the assay.

Using the optimal tracer concentration determined above, a kinase titration is then performed to determine the concentration of kinase required to elicit an approximately 80% change in the assay signal (i.e. the EC₈₀). This is the concentration of kinase that will be used in an assay to determine an IC₅₀ value for an inhibitor.

3. Inhibitor titrations

Using the kinase concentration determined above, the reaction is then performed in the presence of a dilution series of inhibitor, and the amount of inhibitor required to elicit a 50% change in TR-FRET ratio (the IC₅₀) is determined.

The data presented in this document are example data that was generated at Invitrogen. Specific results may vary based upon a variety of factors including the specific activity of the kinase, or the particular plate reader being used. In particular, the Emission Ratio measured can vary greatly between instruments. However, the quality of the data generated should be comparable to the data presented here. If you are reproducing the work presented in this document you should move between the various steps using the values determined in *your* experiments. If you are having trouble reproducing the data presented here, please do not hesitate to contact Invitrogen Technical Services or your Invitrogen representative.

Materials Required

Description	Part Name	Catalog #	Notes
Kinase Reaction Buffer	5X Kinase Buffer A	PV3189	(1)
	Additives: none	N/A	
Kinase	MKNK2	PV5607	
Substrate	RS domain derived peptide	N/A	(2)
Adapta™ Assay Kit:	Adapta™ Universal Kinase Assay Kit	PV5099	(3)
<i>Antibody</i>	<i>Adapta™ Eu-anti-ADP Antibody</i>		(4)
<i>Tracer</i>	<i>10 μM Alexa Fluor® 647 ADP Tracer</i>		
<i>Antibody Dilution Buffer</i>	<i>TR-FRET Dilution Buffer</i>		(5)
<i>500 mM EDTA</i>	<i>Kinase Quench Buffer</i>		
<i>10 mM ATP</i>	<i>10 mM ATP</i>		
<i>10 mM ADP</i>	<i>10 mM ADP</i>		
Inhibitors	Staurosporine	PHZ1271	(6)
	MNK1 inhibitor	N/A	(7)
	Bay439006	N/A	(8)

- (1) The kinase reaction buffer is supplied as a 5X concentrated stock. Prepare a 1x solution from this stock as described below. The 1x kinase reaction buffer is stable at room temperature.
- (2) RS domain derived peptide was obtained from AnaSpec (Part #: 61722). 1mg of RS domain derived peptide was dissolved in 415 μL 1x kinase reaction buffer to make a 2 mM solution. The solution was stored at -20°C until use in the assay.
- (3) The Adapta™ Universal Kinase Assay Kit (PV5099) contains the following components: Adapta™ Eu-anti-ADP Antibody (PV5097; 4 μg); 10 μM Alexa Fluor® 647 ADP Tracer (PV5098; 200 pmol); TR-FRET Dilution Buffer (PV3574; 100 mL); Kinase Quench Buffer (P2825; 1 mL); 10 mM ATP (PV3227; 500 μL); and 10 mM ADP (PV5096; 500 μL).
- (4) The Eu-anti-ADP antibody is supplied at approximately 0.25 mg/mL. The molecular weight of the antibody is 150 kD. Thus, the stock concentration of the antibody is approximately 1.8 μM, or 1800 nM.
- (5) The antibody dilution buffer does not contain EDTA. EDTA (Kinase Quench Buffer; P2832) is added separately, prior to addition of antibody.
- (6) 100 μg of Staurosporine (Invitrogen; PHZ1271) was dissolved in 428.7 μL of DMSO to make a 5 mM solution. The solution was stored at -20°C until used in the assay.
- (7) MNK1 inhibitor was purchased from Calbiochem (Part # 454861). 5mg of MNK1 inhibitor was dissolved in 1.02 ml DMSO to make a 20mM solution. The solution was stored at -20°C until use in the assay.
- (8) BAY439006 was purchased from American Custom Chemicals Corporation. 5mg of Bay439006 was dissolved in 785 μL DMSO to make 10 mM solution. The solution was stored at -20°C until used in the assay.

Adapta™ Assay at a Glance

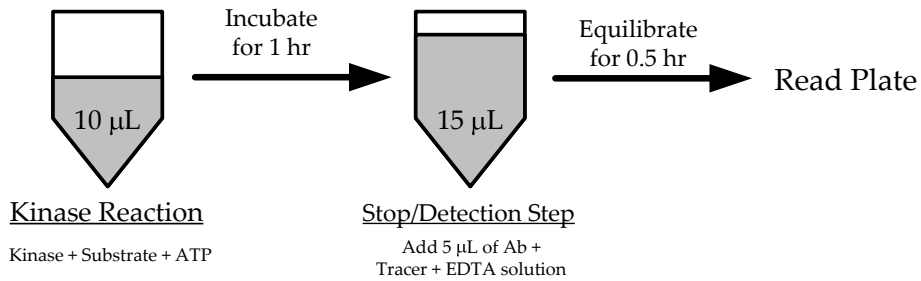
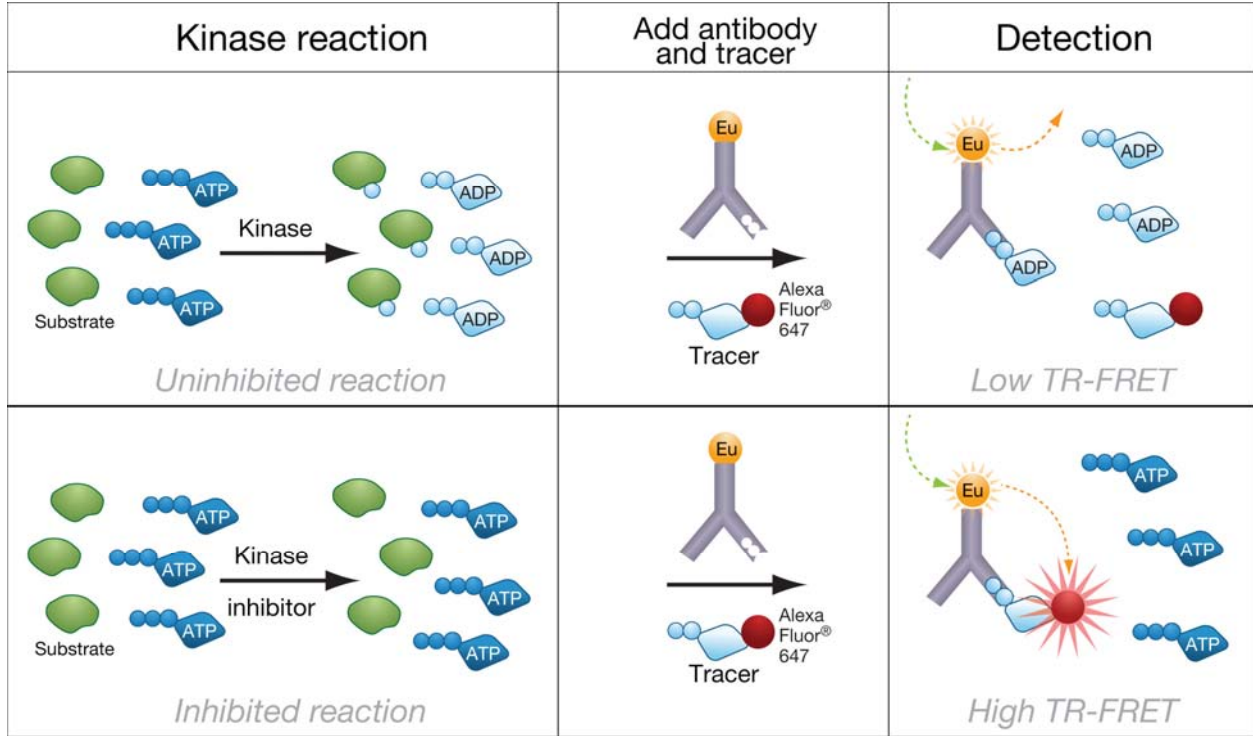

Final Assay Conditions:

<u>Kinase Reaction (10 µL)</u>		<u>Stop/Detection Step (15 µL)</u>	
MKNK2	Variable	Kinase Quench Buffer (EDTA)	10 mM
RS domain derived peptide	200 µM	Adapta Eu-anti-ADP Antibody	2 nM
ATP	10 µM	Alexa Fluor® 647 ADP Tracer	6 nM

Preparing the Kinase Reaction Buffer

Prepare a 1x solution of kinase reaction buffer from the 5x Kinase Buffer A stock (listed above) by adding 2 mL of 5X stock to 8 mL of H₂O to make 10 mL of 1X kinase reaction buffer.

General Assay Conditions

Kinase reactions are performed in a 10 μ L volume in low-volume 384-well plates. Typically, Corning model 3674 (white) plates are used. Other non-treated assay plates, while not tested, may also be suitable. The concentration of substrate in the assay is 200 μ M, and the 1X kinase reaction buffer consists of 50mM HEPES pH 7.5, 10 mM MgCl₂, 1 mM EGTA, 0.01% Brij-35. Kinase reactions are allowed to proceed for 1 hour at room temperature before a 5 μ L preparation of Kinase Quench Buffer (EDTA; 30 mM), Eu-labeled antibody (6 nM), and Tracer (18 nM) in TR-FRET dilution buffer is added. The final concentration of antibody in the assay well is 2 nM, 6 nM for the tracer, and 10 mM for EDTA. The plate is allowed to equilibrate at room temperature for at least 30 minutes before being read on a plate reader configured for Adapta™ TR-FRET.

Plate Readers

The data presented in this document were generated using a BMG LABTECH PHERAstar plate reader using the appropriate filters and instrument settings for Adapta™. The assay can be performed on a variety of plate readers including those from Tecan (Ultra, Infinite F-500, Safire²), Molecular Devices (Analyst and M5), BMG LABTECH PHERAstar and Perkin Elmer (EnVision, Victor, and ViewLux) or any other plate reader configured for Lance® or HTRF® assays. An ATP-ADP Titration curve (See Appendix B) is useful in optimizing plate reader parameters. General instrument settings are listed in the table below:

Excitation	340 nm (30 nm bandpass)
Alexa Fluor® 647 ADP Tracer Emission	665 nm (10 nm bandpass)
Adapta™ Eu-anti-ADP Antibody Emission	615 nm (10 nm bandpass)
Dichroic Mirror	Dichroic 510
Delay Time	100 μ s
Integration Time	200 μ s

Ask your Invitrogen representative for instrument-specific setup guidelines, or contact Invitrogen Discovery Sciences technical support at 800-955-6288 (select option 3 and enter 40266), or email tech_support@invitrogen.com for more information on performing Adapta™ assays on your particular instrument.

Example Protocols

The following protocol describes the various steps in performing a kinase titration in 16-point dilutions in triplicate.

Step 1: Optimization of the concentration of Alexa Fluor® 647 ADP tracer

For this particular protocol, the optimal concentration of tracer has already been determined and the tracer optimization step is skipped to save time and reagents. However, if either the assay buffer or ATP concentration are modified, optimization of the Alexa Fluor® 647 ADP Tracer concentration should be repeated. Detailed instructions on how to perform a tracer optimization is available in Appendix A.

Step 2: Optimization of the concentration of kinase to be used in the assay

- (2.1) In an appropriate tube or vial, prepare 100 μL of kinase in kinase reaction buffer at 2 times the highest concentration of kinase to be tested. In this example, 10 $\mu\text{g}/\text{mL}$ (10,000 ng/mL) is the desired highest concentration of kinase to be tested, and the stock concentration of kinase was 360 $\mu\text{g}/\text{mL}$.

Calculation:

Kinase: Stock = 360 $\mu\text{g}/\text{mL}$ 1x = 10 $\mu\text{g}/\text{mL}$ 2x = 20 $\mu\text{g}/\text{mL}$

		<u>[Initial]</u>		<u>[Final 2x]</u>
Kinase:	5.56 μL	* 360 $\mu\text{g}/\text{mL}$	= 100 μL	* 20 $\mu\text{g}/\text{mL}$
Buffer:	94.4 μL kinase reaction buffer			

Procedure:

Add 5.56 μL of 360 $\mu\text{g}/\text{mL}$ kinase to 94.4 μL kinase reaction buffer.

Keep the diluted kinase on ice until needed.

- (2.2) In a low-volume 384-well plate, fill each well in columns 1–3, rows 2 through 16 (B through P) with 5 μL of kinase reaction buffer. Place 10 μL of the kinase solution as prepared above in the top well of each column, and then perform a 2-fold serial dilution down the plate by removing 5 μL of kinase from the top well, adding this to the well below, mixing, and repeating with the next well below. Discard 5 μL of solution from the bottom well such that each well contains 5 μL of kinase solution.
- (2.3) In an appropriate container, prepare 1 mL of a solution of substrate and ATP in kinase reaction buffer at 2 times the final concentration of each reagent desired in the assay.

If a 1000 μL solution is prepared in a plastic reagent reservoir (trough), then the next addition step can be performed with a multichannel pipette.

Calculations:

Substrate: Stock = 2 mM 1x = 0.2 mM 2x = 0.4 mM

ATP: Stock = 10 mM 1x = 0.01 mM 2x = 0.02 mM

		<u>[Initial]</u>		<u>[Final 2x]</u>
Substrate:	200 μL	* 2 mM	= 1000 μL	* 0.4 mM
ATP:	2 μL	* 10 mM	= 1000 μL	* 0.02 mM
Buffer:	798 μL kinase reaction buffer			

Procedure:

Add 200 μL of RS domain derived peptide and 2 μL of 10 mM ATP to 798 μL kinase reaction buffer.

- (2.4) Start the kinase reaction by adding 5 μL of the substrate + ATP solution prepared in step 2.3 to each well of the assay plate.

- (2.5) Cover the assay plate and allow reaction to proceed for 1 hour at room temperature.
- (2.6) ***Optional Step*** An ATP-ADP titration curve can be used to assure that the assay is being performed under conditions of initial rates (typically, < 20% conversion of substrate to product) as well as to create a standard curve to calculate substrate conversion values from the raw TR-FRET emission ratios (Appendix C). While the kinase reaction is incubating, you can prepare an ATP-ADP titration curve as outlined in Appendix B and add the solution to the appropriate wells of the 384-well plate.
- (2.7) Prior to completion of the kinase reaction, prepare 1 mL of a solution of EDTA (Kinase Quench Buffer), Eu-anti-ADP antibody, and ADP Tracer at 3 times the desired final concentrations of each reagent in TR-FRET dilution buffer. The antibody is stable in EDTA for several hours, but because it is sensitive to high concentrations of EDTA, we recommend first adding the concentrated EDTA to the dilution buffer, mixing the solution well, and then adding the antibody before mixing further.

Calculations:

Kinase Quench buffer (EDTA):	Stock = 500 mM	1x = 10 mM	3x = 30 mM
Antibody:	Stock = 1700 nM	1x = 2 nM	3x = 6 nM
Tracer:	Stock = 10.0 μM	1x = 0.006 μM	3x = 0.018 μM

			[Initial]		[Final 2x]
EDTA:	60 μL	*	500 mM	= 1000 μL	* 30 mM
Antibody:	3.53 μL	*	1700 nM	= 1000 μL	* 6 nM
Tracer:	1.8 μL	*	10.0 μM	= 1000 μL	* 0.018 μM
Buffer:	934.7 μL TR-FRET Dilution Buffer				

Procedure:

Add 60 μL of Kinase Quench Buffer (EDTA), 3.53 μL of 1700 nM antibody and 1.8 μL of 10 μM Tracer to 934.7 μL TR-FRET Dilution Buffer.

- (2.8) Add 5μL of the Tracer + Antibody + EDTA solution prepared in step 2.7 to each well of the assay plate and mix briefly, either by pipette or on a plate shaker.
- (2.9) Cover the assay plate and allow the plate to equilibrate for at least 30 minutes at room temperature before reading on an appropriate plate reader.
- (2.10) Plot the resulting TR-FRET emission ratio against the concentration of kinase (ng/mL). The amount of kinase necessary to displace 80% of the ADP tracer from the antibody (i.e. observe a ~80% decrease in assay signal, the EC₈₀) is the concentration of kinase that will be used in the inhibitor titration experiments to determine an IC₅₀ values. Fit the data to a sigmoidal dose-response curve with a variable slope and calculate the EC₈₀ concentration from the curve. The following equation can be used with GraphPad™ Prism® software:

$$F=80$$

$$\log EC_{50} = \log ECF - (1/\text{HillSlope}) * \log(F/(100-F))$$

$$Y = \text{Bottom} + (\text{Top} - \text{Bottom}) / (1 + 10^{((\text{Log} EC_{50} - X) * \text{HillSlope})})$$

Figure 1: Example of Kinase Titration at 10 μ M ATP.

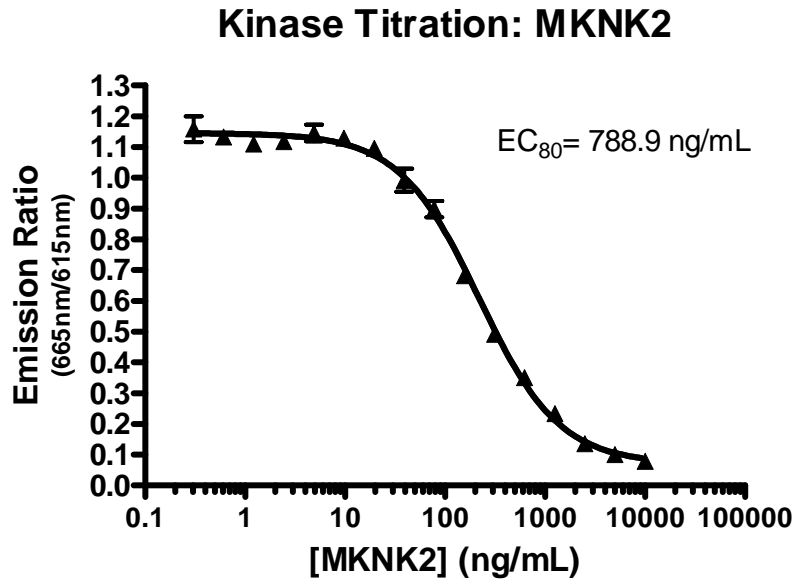

Representative data of the titration of MKNK2 is shown above. Although assay window and signal will vary between plate readers, the quality of the data generated should be comparable to the data presented above. For inhibitor titration experiments, the amount of kinase required to observed an ~ 80% decrease in the assay window (the EC₈₀) is determined. From the example data above, 788.9 ng/mL (10.7 nM) of kinase was required to achieve the 80% decrease in the assay window.

If you are reproducing the work presented in this document you should move between the various steps using the values determined in your experiments.

Step 3: Inhibitor Titrations

The general procedure for determining an inhibitor IC_{50} value is as follows:

1. Add 2.5 μL of inhibitor in 4% DMSO at 4-fold the final assay concentration to triplicate assay wells.
2. To start the reaction, add 2.5 μL of kinase at 4-fold the final assay concentration, followed by a 5 μL addition of substrate and ATP at 2-fold the final reaction concentrations.
3. The remainder of the protocol is similar to previous steps.

A more detailed protocol follows.

- (3.1) A dilution series of inhibitor in 100% DMSO is first prepared at 100 times the concentrations to be assayed. By performing the initial dilutions in 100% DMSO, solubility problems associated with dilutions into aqueous buffer can be minimized.

This “master” dilution series of inhibitor can be prepared in two separate 8-tube PCR strips, and stored at -20° or -80° for use in future experiments. The dilutions are “staggered” between strips as shown in the left side of Figure 2.

1. Add 50 μL of DMSO to tubes 2–8 of strip A, and all tubes of strip B.
2. Add 100 μL of inhibitor in DMSO, at 100-fold the highest concentration to be tested in the experiment, to tube 1 of strip A. For example, if the highest concentration to be tested in the assay is 10 μM ; the 100X solution would be: $100 \times 10 \mu\text{M} = 1 \text{ mM}$.
3. Transfer 50 μL of inhibitor from tube 1 of strip A to tube 1 of strip B.
4. After mixing, transfer 50 μL from tube 1 of strip B to tube 2 of strip A.
5. This process is repeated for all but the final tube of strip B, which contains only DMSO (no inhibitor).

Figure 2: Preparing a Dilution Series of Inhibitor

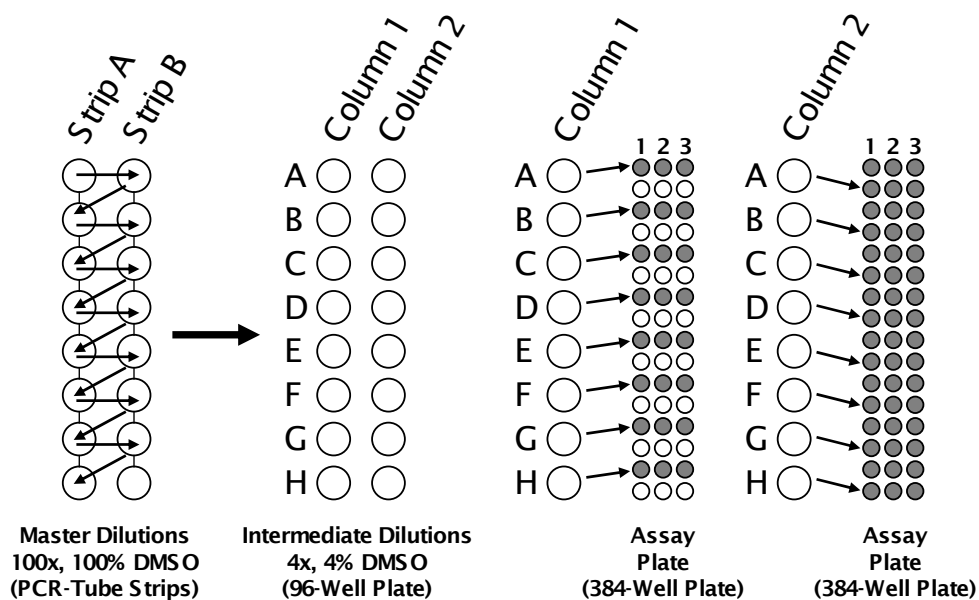

- (3.2) From the master dilutions of inhibitor in 100% DMSO, intermediate dilutions are prepared in two columns of a 96-well plate. The 96-well plate is used only as a convenient vessel for preparing the intermediate dilutions.

1. First, place 96 μL of kinase reaction buffer into all wells of two columns of a 96-well plate.

2. Then, transfer 4 μL of the master inhibitor stock from strip A into column 1 of the 96 well plate, and 4 μL of the master inhibitor stock from strip B into column 2 of the 96-well plate.
 3. Mix the solutions well, either with a plate shaker or by mixing with a 20 μL multichannel pipette.
 4. Using an 8-channel pipette, add 2.5 μL of inhibitor from the intermediate dilution in the 96-well plate to the 384-well assay plate as shown in figure 2. Use column 1 of the intermediate stock to fill rows A, C, E, etc. of the 384-well assay plate, and column 2 to fill the alternating rows B, D, F, etc.
- (3.3) Prepare a 1 mL solution of kinase in kinase reaction buffer at 4x the final desired reaction concentration of the kinase. From the kinase titration experiment in Step 2, 788.9 ng/mL of MKNK2 was determined to be the concentration required for the assay.

Calculation:

$$\text{Kinase: Stock} = 360 \mu\text{g/mL} \quad 1x = 0.789 \mu\text{g/mL} \quad 4x = 3.16 \mu\text{g/mL}$$

	<u>[Initial]</u>			<u>[Final 4x]</u>
Kinase:	8.78 μL	*	360 $\mu\text{g/mL}$	= 1000 μL * 3.16 $\mu\text{g/mL}$
Buffer:	991.2 μL kinase reaction buffer			

Procedure:

Add 8.78 μL of 360 $\mu\text{g/mL}$ kinase to 991.2 of a solution of substrate and ATP in kinase reaction buffer at 2 times the final concentration of each reagent desired in the assay.

- (3.4) Add 2.5 μL of the kinase solution prepared in step 3.3 to each well of the assay plate.
- (3.5) In an appropriate container, prepare 1 mL of a solution of substrate and ATP in kinase reaction buffer at 2 times the final concentration of each reagent desired in the assay.

If a 1000 μL solution is prepared in a plastic reagent reservoir (trough), then the next addition step can be performed with a multi-channel pipette.

Calculations:

$$\begin{array}{l} \text{Substrate: Stock} = 2 \text{ mM} \quad 1x = 0.2 \text{ mM} \quad 2x = 0.4 \text{ mM} \\ \text{ATP: Stock} = 10 \text{ mM} \quad 1x = 0.01 \text{ mM} \quad 2x = 0.02 \text{ mM} \end{array}$$

		<u>[Initial]</u>			<u>[Final 2x]</u>
Substrate:	200 μL	*	2 mM	= 1000 μL *	0.4 mM
ATP:	2 μL	*	10 mM	= 1000 μL *	0.02 mM
Buffer:	798 μL kinase reaction buffer				

Procedure:

Add 200 μL of RS domain derived peptide and 2 μL of 10 mM ATP to 798 μL kinase reaction buffer.

- (3.6) Start the kinase reaction by adding 5 μL of the substrate + ATP solution prepared in step 3.5 to each well of the assay plate.
- (3.7) Cover the assay plate and allow reaction to proceed for 1 hour at room temperature.
- (3.8) ***Optional Step*** An ATP-ADP titration curve can be used to assure that the assay is being performed under conditions of initial rates (typically, < 20% conversion of substrate to product) as well as to create a standard curve to calculate substrate conversion values from the raw TR-FRET emission ratios (Appendix C). While the kinase reaction is incubating, you can prepare an ATP-ADP titration curve as outlined in Appendix B and add the solution to the appropriate wells of the 384-well plate.

- (3.9) Prior to completion of the kinase reaction, prepare 1 mL of a solution of Kinase Quench Buffer (EDTA), Eu-anti-ADP antibody, and ADP Tracer at 3 times the desired final concentrations of each reagent in TR-FRET dilution buffer. The antibody is stable in EDTA for several hours, but because it is sensitive to high concentrations of EDTA we recommend first adding the concentrated EDTA to the dilution buffer, mixing the solution well, and then adding the antibody before mixing further.

Calculations:

Kinase Quench buffer (EDTA):	Stock = 500 mM	1x = 10 mM	3x = 30 mM
Antibody:	Stock = 1700 nM	1x = 2 nM	3x = 6 nM
Tracer:	Stock = 10.0 μM	1x = 0.006 μM	3x = 0.018 μM

			<u>[Initial]</u>			<u>[Final 2x]</u>
EDTA:	60 μL	*	500 mM	=	1000 μL	* 30 mM
Antibody:	3.53 μL	*	1700 nM	=	1000 μL	* 6 nM
Tracer:	1.8 μL	*	10.0 μM	=	1000 μL	* 0.018 μM
Buffer:	934.7 μL TR-FRET Dilution Buffer					

Procedure:

Add 60 μL of Kinase Quench Buffer (EDTA), 3.53 μL of 1700 nM antibody and 1.8 μL of 10 μM Tracer to 934.7 μL TR-FRET Dilution Buffer.

- (3.10) Add 5μL of the Tracer + Antibody + EDTA solution prepared in step 3.9 to each well of the assay plate and mix briefly, either by pipette or on a plate shaker.
- (3.11) Cover the assay plate and allow the plate to equilibrate for 30 minutes at room temperature before reading on an appropriate plate reader.
- (3.12) Plot the resulting TR-FRET emission ratio against the concentration of inhibitor, and fit the data to a sigmoidal dose-response curve with a variable slope. Alternatively, the data can also be plotted as % conversion versus the concentration of inhibitor as outline in Appendix C. Calculate the EC₅₀ concentration from the curve. This is equal to the IC₅₀ value for the inhibitor.

For the comparison of inhibitors across multiple experiments, it may be advantageous to graph the inhibition titrations as % inhibition (instead of TR-FRET ratio) versus inhibition concentration. To convert from TR-FRET ratio to % inhibition:

$$\% \text{ Inhibition} = \frac{100 \times (Ratio_{\text{Sample}} - Ratio_{0\% \text{ Inhibition}})}{Ratio_{100\% \text{ Inhibition}} - Ratio_{0\% \text{ Inhibition}}}$$

The 0% inhibition value comes from a control well lacking inhibitor. The 100% inhibition value comes from a control well either containing a saturating amount of a known inhibitor, or lacking kinase. Because of the way the Adapta™ assay is formatted, the 100% inhibition control well cannot be a well simply lacking ATP.

Figure 3: Example IC₅₀ Curves

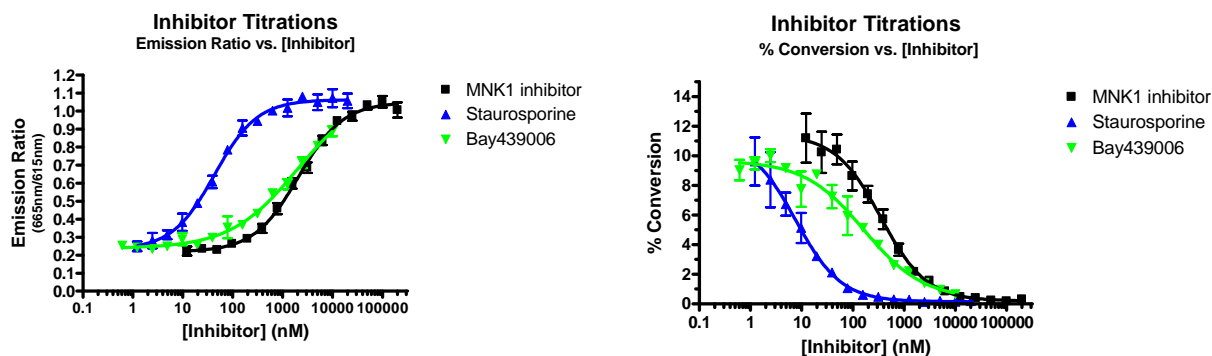

The inhibition of MKNK2 with the inhibitor MNK1 inhibitor, Staurosporine and Bay439006 are displayed above. The inhibition curve is plotted as both Emission ratio versus inhibitor concentration and % conversion versus inhibitor concentration (See Appendix C) for comparison.

The IC₅₀ value for inhibition of MKNK2 with the above inhibitor is shown in the table below.

Kinase	Inhibitor	IC ₅₀ (nM)		
		Literature	Adapta™ Assay	
			From Emission Ratio	From % Conversion
MKNK2	MNK1 inhibitor	NR	2100	350
	Staurosporine	17 ¹	43	7.6
	Bay439006	130 ¹	2000	160

NR = No value reported

¹Karaman, M.Z., *et al. Nat. Biotechnol.* **26**(1) 127-132 (2008)

Appendix A

Optimization of the Alexa Fluor[®] 647 ADP Tracer Concentration

(A.1) Prepare 10 mL of 1X kinase reaction buffer with 10 μ M ATP.

NOTE The concentration of ATP added to the assay buffer should be equal to the desired concentration of ATP in the kinase reaction (in this example 10 μ M).

Calculation:

ATP: Stock = 10 mM 1x = 0.01 mM

			<u>[Initial]</u>			<u>[Final]</u>
ATP:	10 μ L	*	10 mM	=	10000 μ L	0.01 mM
Buffer:	9990 μ L kinase reaction buffer					

Procedure:

Add 10 μ L of 10 mM ATP to 9990 μ L of 1x kinase reaction buffer.

(A.2) In an appropriate tube or vial, prepare 100 μ L of 300 nM Alexa Fluor[®] 647 ADP Tracer in reaction buffer from Step A.1 at 1.5 times the highest concentration of tracer to be tested. In this example, 200 nM was the desired highest concentration of tracer to be tested, and the stock concentration of tracer was 10.0 μ M.

Calculation:

ADP Tracer: Stock = 10.0 μ M 1x = 0.2 μ M 1.5x = 0.3 μ M

			<u>[Initial]</u>			<u>[Final 1.5x]</u>
ADP Tracer:	3.0 μ L	*	10.0 μ M	=	100 μ L	*
Buffer:	97 μ L kinase reaction buffer with 10 μ M ATP					

Procedure:

Add 3.0 μ L of 10.0 μ M ADP Tracer to 97 μ L of reaction buffer with 10 μ M ATP from Step A.1.

(A.3) In a low-volume 384-well plate, fill each well in columns 1–3, rows 2 through 16 (B through P) with 10 μ L of reaction buffer with 10 μ M ATP from Step A.1. Place 20 μ L of the 300 nM tracer solution as prepared above in the top well of each column, and then perform a 2-fold serial dilution down the plate by removing 10 μ L of tracer solution from the top well, adding this to the well below, mixing, and repeating with the next well below. Discard 10 μ L of solution from the bottom well such that each well contains 10 μ L of solution.

(A.4) Prepare 1 mL of a solution of Kinase Quench Buffer (EDTA) and Adapta[™] Eu-anti-ADP antibody at 3 times the desired final concentrations of each reagent in TR-FRET dilution buffer. The antibody is stable in EDTA for several hours, but because it is sensitive to high concentrations of EDTA we recommend first adding the concentrated EDTA to the dilution buffer, mixing the solution well, and then adding the antibody before mixing further.

Calculations:

Kinase Quench Buffer (EDTA): Stock = 500 mM 1x = 10 mM 3x = 30 mM
 Antibody: Stock = 1700 nM 1x = 2 nM 3x = 6 nM

			<u>[Initial]</u>			<u>[Final 2x]</u>
EDTA:	60 µL	*	500 mM	=	1000 µL	* 30 mM
Antibody:	3.53 µL	*	1700 nM	=	1000 µL	* 6 nM
Buffer:	996.5 µL TR-FRET Dilution Buffer					

Procedure:

Add 60 µL of Kinase Quench Buffer (EDTA) and 3.53 µL of 1800 nM antibody to 996.5 µL TR-FRET Dilution Buffer.

- (A.5) Add 5µL of the Antibody + EDTA solution prepared in step A.4 to each assay well and mix briefly, either by pipette or on a plate shaker.
- (A.6) Cover the assay plate and incubate for at least 30 minutes at room temperature before reading on an appropriate plate reader.
- (A.7) Plot the resulting TR-FRET emission ratio against the concentration of ADP Tracer. The final concentration of tracer in the first well was 400 nM and a 2-fold serial dilution was performed. Fit the data to a sigmoidal dose-response curve with a variable slope and calculate the EC₅₀ concentration from the curve. The following equation can be used with GraphPad™ Prism® software:

$$F=50$$

$$\log EC_{50} = \log ECF - (1/\text{HillSlope}) * \log(F/(100-F))$$

$$Y = \text{Bottom} + (\text{Top} - \text{Bottom}) / (1 + 10^{((\text{Log} EC_{50} - X) * \text{HillSlope})})$$

Alternatively, the amount of ADP Tracer needed to elicit a 50% change in TR-FRET response may be estimated from a visual inspection of the curve. It is important that the EC₅₀ concentration of the Alexa Fluor® 647 ADP Tracer determined from this titration be used in the following steps to obtain optimal signal in the kinase assay.

Figure A.1: Example titration of Alexa Fluor® 647 ADP Tracer

Alexa Fluor® 647 ADP Tracer Titration in Kinase Buffer A

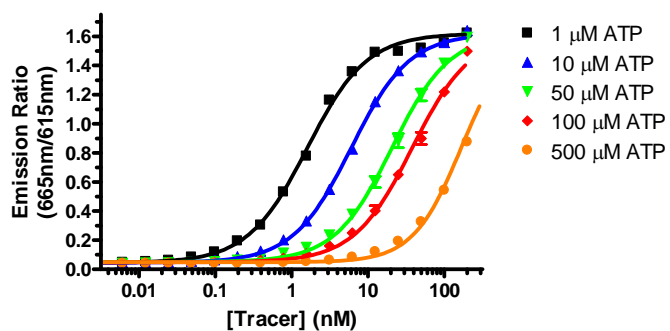

Assay Concentration of ATP	Optimal Concentration of Alexa Fluor® 647 ADP Tracer
1 μM	1.6 nM
10 μM	6.0 nM
50 μM	20.7 nM
100 μM	38.1 nM
500 μM	166.7 nM

The optimal concentration of Alexa Fluor® 647 ADP Tracer was determined at a range of ATP concentrations in the stated kinase reaction buffer. For 10 μM ATP, an EC₅₀ value of 6 nM was obtained. Based on this result, an Alexa Fluor® 647 ADP tracer concentration of 6 nM will be used in the kinase and inhibitor titrations with MKNK2 when an ATP concentration of 10 μM is used.

Appendix B

ATP-ADP Titration Curve

The ATP-ADP titration curve can be useful to aid in instrument optimization, or to assure that the assay is being performed under conditions of initial rates (typically, < 20% conversion of substrate to product). Since the interaction of the europium labeled antibody and the ADP tracer is dependant on the total amount of ATP and ADP present, it is important to maintain a constant nucleotide concentration in the ATP-ADP titration curve. A 1.5 fold “master” dilution series of ATP-ADP is prepared in a 96-well plate, and can be stored at room temperature until required for the assay. The dilutions are “staggered” between columns of a 96-well plate as shown in Figure B.1. The 96-well plate is used only as a convenient vessel for preparing the ATP-ADP standard curve.

***Note:** If you are using the ATP-ADP Titration curve to calculate % conversion (See Appendix C), it is important to include the substrate (at the concentration used in the assay) in your ATP and ADP solutions.

- (B.1) Prepare a 4 mL solution of ATP and a 1 mL solution ADP such that each is at the desired concentration of ATP that will be used in the kinase assay (i.e. if [ATP] in assay = 10 μ M then prepare a 4 mL solution of 10 μ M ATP and a 1 mL solution of 10 μ M ADP, each in kinase assay buffer).
- (B.2) Place 100 μ L of the ATP solution to every well of Column 1 & 2 of the 96-well plate EXCEPT well A-1. To well A-1, add 300 μ L of the ADP solution.
- (B.3) Transfer 200 μ L of solution from well A-1 to well A-2 and mix thoroughly. Next, transfer 200 μ L of solution from well A-2 to well B-1 and mix thoroughly. Repeat this process for all remaining wells, discarding 200 μ L of reagent from the final well (See Figure B.1).
- (B.4) Using a multi-channel pipette, transfer 10 μ L of the ATP-ADP titration curve in the 96-well plate to the respective wells of a 384-well plate as shown in Figure 6. Reagent from column 1 of the 96 well plate being placed in the 1st, 3rd, 5th (etc) rows of the 384-well plate, and reagent from column 2 of the 96 well plate being placed in alternate (2nd, 4th, etc) rows of the 384 well plate.

If you are performing the ATP-ADP Titration as a part of the kinase titration or inhibitor titration, return to the respective step within the procedure.

If you are performing the ATP-ADP Titration curve independently of the kinase and inhibitor titration experiments (i.e. as an instrument control):

- (B.5) Prepare 1 mL of a solution of Kinase Quench Buffer (EDTA), Eu-anti-ADP antibody, and ADP Tracer at 3 times the desired final concentrations of each reagent in TR-FRET dilution buffer. The antibody is stable in EDTA for several hours, but because it is sensitive to high concentrations of EDTA we recommend first adding the concentrated EDTA to the dilution buffer, mixing the solution well, and then adding the antibody before mixing further.

Calculations:

Kinase Quench buffer (EDTA):	Stock = 500 mM	1x = 10 mM	3x = 30 mM
Antibody:	Stock = 1800 nM	1x = 2 nM	3x = 6 nM
Tracer:	Stock = 10.0 μ M	1x = 0.006 μ M	3x = 0.018 μ M

			<u>[Initial]</u>		<u>[Final 2x]</u>
EDTA:	60 μ L	*	500 mM	= 1000 μ L	* 30 mM
Antibody:	3.53 μ L	*	1700 nM	= 1000 μ L	* 6 nM
Tracer:	1.8 μ L	*	10.0 μ M	= 1000 μ L	* 0.018 μ M
Buffer:	934.7 μ L TR-FRET Dilution Buffer				

Procedure:

Add 60 μ L of Kinase Quench Buffer (EDTA), 3.3 μ L of 1800 nM antibody and 1.8 μ L of 10 μ M Tracer to 934.7 μ L TR-FRET Dilution Buffer.

- (B.6) Add 5 μ L of 3X detection solution consisting of Adapta™ Eu-anti-ADP antibody + Alexa Fluor® 647 ADP tracer + Kinase Quench Buffer (EDTA) to each well.
- (B.7) Cover the assay plate and allow the plate to equilibrate for at least 30 minutes at room temperature before reading on an appropriate plate reader.
- (B.8) Plot the resulting TR-FRET emission ratio against the % Conversion of ATP to ADP. See Figure B.2.

Figure B.1: Preparation of an ATP-ADP Titration Curve

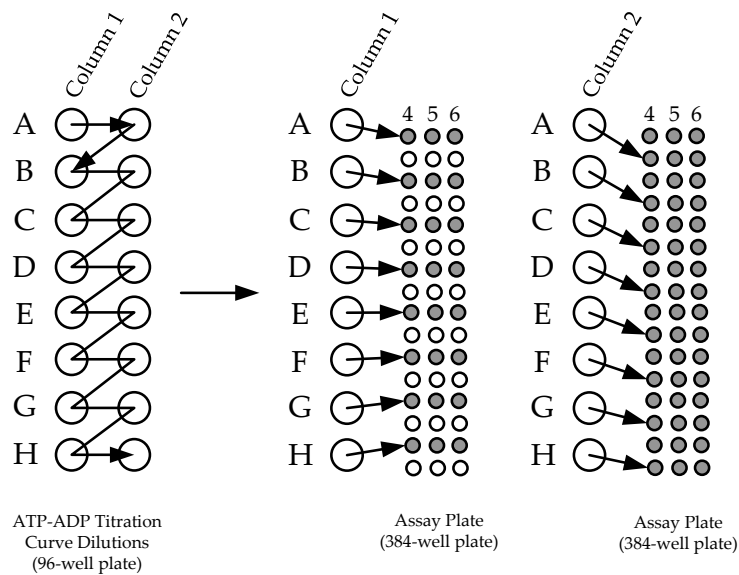

Figure B.2 Respective % conversion of ATP to ADP in the titration curve with a total nucleotide concentration of 10 μ M. The calculations are based upon a 1.5 fold serial dilution within the ATP-ADP titration curve.

Well in 96-well plate	Correspond row in 384-well plate	% Conversion of ATP to ADP
A1	A	100.0%
A2	B	66.7%
B1	C	44.4%
B2	D	29.6%
C1	E	19.8%
C2	F	13.2%
D1	G	8.8%
D2	H	5.9%
E1	I	3.9%
E2	J	2.6%
F1	K	1.7%
F2	L	1.2%
G1	M	0.8%
G2	N	0.5%
H1	O	0.3%
H2	P	0.2%

Appendix C

Calculating Percent Conversion

If an ATP-ADP titration curve is performed in combination with the inhibitor titration experiments (Section 3), a percent conversion can be determined as follows:

- (C.1) Plot the TR-FRET Emission Ratio vs. the % conversion of ATP to ADP for your ATP-ADP titration curve.

ATP-ADP Titration Curve

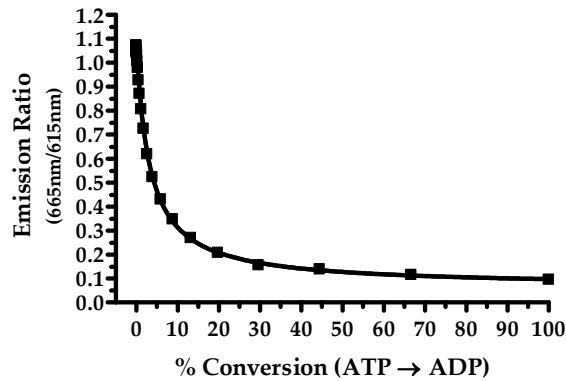

- (C.2) Fit the plot to a 3-parameter hyperbolic model using an appropriate data analysis program. The following equation can be used with GraphPad™ Prism® software:

$$Y = C + A \left(1 - \frac{X}{B + X} \right)$$

- (C.3) Calculate % conversion based upon the results in Step C.2 and the following equation:

$$\% \text{ Conversion} = B \left(\frac{C + A - \text{Ratio}}{\text{Ratio} - C} \right)$$

In this equation, “Ratio” is the TR-FRET emission value of your sample in the inhibitor experiment.

- (C.4) Plot the % Conversion vs. the concentration of inhibitor and fit the data to a sigmoidal dose-response curve with a variable slope. Calculate the EC₅₀ concentration from the curve. This is equal to the IC₅₀ value for the inhibitor.

Appendix D

ATP_{K_{m,app}} Determination in Radiometric Assay

To facilitate inhibitor studies, ATP_{K_{m,app}} values were determined for the protein kinases in a radiometric assay. The kinase reaction conditions for the radiometric assays were identical to those for the Adapta™ assays, including buffer and substrate concentrations, with the exception of variable amounts of ATP, a different enzyme concentration, and inclusion of trace γ -³²P ATP. Assay conditions are summarized in Table D.1. Briefly, 30 μ L kinase reactions were performed at room temperature for between 10 and 20 minutes and stopped by transferring 20 μ L of reaction mix onto a P81 filter. Then the filters were washed with 0.5% phosphoric acid and water and were counted in a liquid scintillation counter. The determined ATP K_{m,app} values are in Table D.1 and the Michaelis-Menten plot for MKNK2 is displayed in Figure D.2.

Table D.1: Reaction conditions

Enzyme	Substrate	Assay Buffer	ATP K _{m,app} (μ M)	[Enzyme] (μ g/mL)
CAMK1	200 μ M ZIPtide	Kinase Buffer A + 2 mM CaCl ₂ + 20 μ g/mL calmodulin	845 +/- 146 μ M	0.8
CDK7	200 μ M Cdk7/9tide	Kinase Buffer A	59 +/- 4 μ M	1.67
CDK9	200 μ M Cdk7/9tide	Kinase Buffer A	17 +/- 1 μ M	1.67
DAPK1	200 μ M ZIPtide	Kinase Buffer A + 2 mM CaCl ₂ + 20 μ g/mL calmodulin	5.8 +/- 0.6 μ M	0.83
LRRK2	400 μ M ERM (LRRKtide)	Kinase Buffer S + 2 mM DTT	57 +/- 4 μ M	2.1
LRRK2 G2019S	400 μ M ERM (LRRKtide)	Kinase Buffer S + 2 mM DTT	134 +/-4 μ M	1.0
MKNK2	200 μ M RS domain derived peptide	Kinase Buffer A	136 +/-20 μ M	0.83

Figure D.2: Michaelis-Menten plot for MKNK2

